

STANLEY[®]
Access Technologies



HEALTHCARE DOOR SOLUTIONS

PERFORMANCE IN ACTION.

SELECTION GUIDE

DOORS BY APPLICATION

The products listed in the selection guide are suggestions only. Reach out to your local STANLEY Spec Writer to discuss your specific project requirements.

SLIDING DOORS

SWING OPERATORS

Applications	ICU/CCU ProCare™ Series	ICU/CCU Dura-Care™ Series	Automatic Sliding Dura-Glide® 2000/3000 Series	Automatic Telescoping DuraFit™ & Dura-Glide® 5200/5300	M-Force™	Magic Access™
Acute Patient Rooms	•	•				
Admin Areas			•	•	•	•
Main Entrances/ ER Entrances			•	•	•	
Inpatient ICU	•	•				
Patient/Public Restrooms		•			•	•
Pharmacy/Labs	•	•	•		•	
Procedure Rooms	•	•	•		•	•
Exam Rooms	•	•				•
Corridors			•	•	•	
FGI Airborne Isolation/ Pressurized Rooms	•	•				
Clean Room Certified	• 8300A and 8500A		•	• Dura-Glide® 5200/5300		
Smoke & Draft (UL-1784) Option	•	•				



ProCare™ Series ICU/CCU Doors

Designed with respect for patients and caregivers in sensitive healthcare environments, the ProCare™ Series is ideal for healthcare settings requiring frequent patient transfers, privacy, and isolation rooms. Various customizable options to choose from, including custom finishes, 2-panel, 3-panel, or 4-panel design options, and manual or automatic operation.

The ProCare™ Difference:

- The widest clear door openings in the industry
- Privacy solutions available, including blinds or electronic privacy glass
- Eliminate dangerous snagging of IV lines and equipment during patient transport with our catchfree handle design
- Easy, quiet, and more controlled breakaway and return with our instant utility breakout button
- Smoke & Draft Rating (UL 1784) option and FGI Airborn Isolation/Pressurized Room option available on all models

SELECTION GUIDE

PROCARE™ SERIES ICU/CCU DOORS

The products listed in the selection guide are suggestions only. Reach out to your local STANLEY Spec Writer to discuss your specific project requirements.

Features	ProCare™ 8300	ProCare™ 8300A	ProCare™ 8300BP	ProCare™ 8500	ProCare™ 8500A
Clear Door Opening Maximum	50.2"	49.4"	77.1"	72.3"	72.5"
Automatic Operation		•			•
Synchronized Panels (Telescopic)				•	•
Trackless	•	•	•	•	•
Full Utility Breakout	•	•	•	•	•
Panel Design Options	2-Panel	2-Panel	4-Panel	3-Panel	3-Panel
Self-Closing Option	•	•	•	•	•
Electro-Magnetic Hold Open	•		•	•	
Smoke & Draft Rated (UL 1784) Option	•	•	•	•	•
FGI Airborne Isolation/ Pressurized Room Option	•	•	•	•	•
Clean Room Certified		•			•
Positive Latch Option	•	•	•	•	•
Integral Blinds Option	•	•	•	•	•
Electronic Privacy Glass Option	•	•		•	•
Electronic Lock Security Option		•			•

PROCARE™ 8300: TRACKLESS 2-PANEL MANUAL SLIDING DOOR

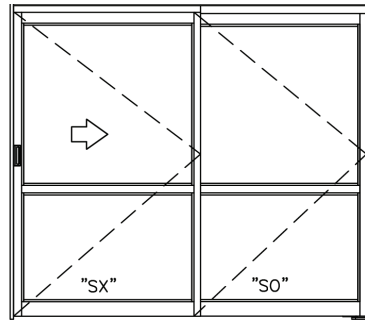

Description: Easy and more controlled utility break out and return with our intuitive break out button. Quiet and reliable operation with our break out guidance system. Minimal panel sag during break out.

Solution for: Patient privacy, frequent break out and reset, Smoke & Draft Rating Option, Isolation Package, STC Rating

Breakout: Full Utility Breakout

Typical Frame Width: Range: 84" to 108"

[More Information](#)

PROCARE™ 8300A AUTOMATIC: TRACKLESS 2-PANEL AUTOMATIC SLIDING DOOR

Description: Easily switches to manual slide mode, giving nurses the control they need to monitor patients. Exclusive Assisted Manual Operation Technology makes manual sliding 3 times easier. Touchless activation to prevent the spread of infection. Overhead sensors safely keeps the door panel open when someone is within 2 feet of the opening.

Solution for: Patient privacy, frequent break out and reset, Smoke & Draft Rating Option, Isolation Package, Clean Room, STC Rating

Breakout: Full Utility Breakout

Typical Frame Width: Range: 84" to 108"

[More Information](#)

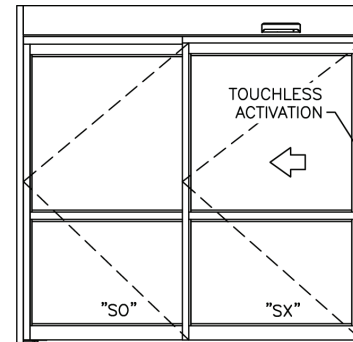

PROCARE™ 8300BP BI-PART: 4-PANEL MANUAL BI-PARTING DOOR

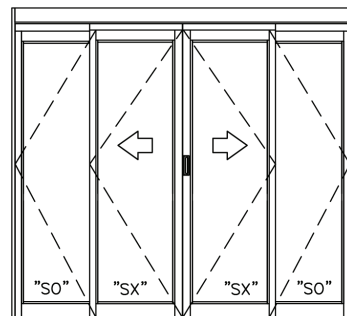

Description: Space-optimizing manual door with compact 4-panel bi-parting door features a smaller breakaway arc to meet corridor codes. Effortless one-handed operation slides both center panels simultaneously.

Solution for: Patient privacy, frequent break out and reset, Smoke & Draft Rating Option, Isolation Package, STC Rating

Breakout: Full Utility Breakout

Typical Frame Width: Range 84" to 168"

[More Information](#)

▲ PROCARE™ 8500: 3-PANEL TELESCOPING MANUAL SLIDING DOOR

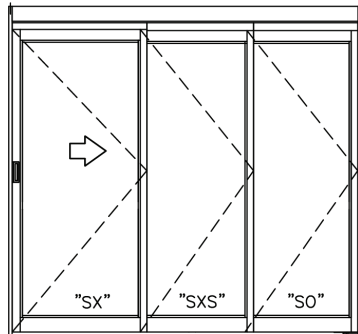

Description: The largest clear door opening in the industry for a telescopic 3-panel door system. Low-profile header provides improved height clearance.

Solution for: Patient privacy, frequent break out and reset, Smoke & Draft Rating, Isolation Package, Clean Room, STC Rating

Breakout: Full Utility Breakout

Typical Frame Width: 84" to 120"

Typical Clear Door Opening (CDO): 56.8" at 96" package width (7/8" jambs)

Header Size: 4 1/8" Nominal Height

[More Information](#)

The ProCare™ 8500 and ProCare™ 8500A share the same shortened header, allowing for an improved aesthetic for corridors with a combination of automatic and manual doors. For retrofit applications, easily replace older manual ICU doors with modern automatic doors without losing vertical CDO (clear door opening.)

▲ PROCARE™ 8500A: 3-PANEL TELESCOPING AUTOMATIC SLIDING DOOR

Description: Easily switches to manual slide mode, giving nurses the control they need to monitor patients. Exclusive Assisted Manual Operation Technology makes manual sliding 3 times easier.

Touchless activation to prevent the spread of infection. Overhead sensors safely keep the panels open when someone is within 2 feet of the open door.

Solution for: Patient privacy, frequent break out and reset, Smoke & Draft, Isolation Package, Clean Room, STC Rating

Breakout: Full Utility Breakout

Typical Frame Width: 84" to 122"

Typical Clear Door Opening (CDO): 55.7" at 96" package width (1 3/4" jambs)

Header Size: 4 1/8" Nominal Height

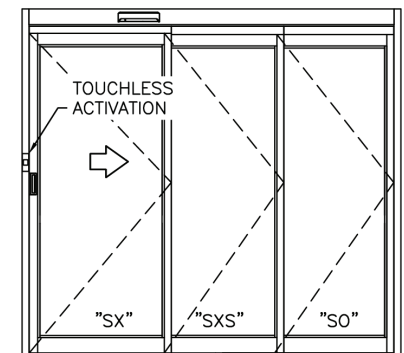

[More Information](#)



Dura-Care™ Series ICU/CCU Doors

The Dura-Care™ Series is a cost-effective option offering a wide range of configurations, including manual and automatic operation, slide or swing, and various panel design options. Further customization is available with various activation options and features.

Description:

- The Dura-Care™ Series has a range of clear door opening options
- Privacy solutions available, including blinds or electronic privacy glass
- Manual ICU door solutions with automatic options available
- Various customizable options to choose from including Smoke & Draft Rating option, and Isolation Package
- Utility breakaway function provides wide openings for patient and equipment transfer

SELECTION GUIDE

DURA-CARE™ SERIES ICU/CCU DOORS

The products listed in the selection guide are suggestions only. Reach out to your local STANLEY Spec Writer to discuss your specific project requirements.

Features	Dura-Care™ 7000 TL	Dura-Care™ 7200	Dura-Care™ 7300 TL-FBO	Dura-Care™ 7500A	Dura-Care™ 7500TL	Dura-Care™ 7500TL-FBO	Dura-Care™ 7400 Swing	Dura-Care™ 7600 Swing
Automatic Operation				•				
Clear Door Opening Maximum	68.3" BP	72.3" BP	50.2"	60.6"	91.5"	81.2" BP	91.5" (Pair)	99.8"
Synchronized Panels (Telescopic)				•	•			
Trackless	•	•	•	•	•	•	•	•
Utility Breakout	Full	Partial	Full	Full	Partial Only Lead Sliding Panel	Full	Full	Full
Panel Design Options	2-Panel or 4-Panel	2-Panel or 4-Panel	2-Panel	3-panel	3-Panel or 6-Panel	3-Panel or 6-Panel	1- Panel or 2-Panel	3-Panel
Surface Mounted (P-Panel) Option		•			•			
Self-Closing Option	•	•	•	•	3-Panel	3-Panel	•	
Smoke & Draft Rated (UL 1784) Option	2-Panel	2-Panel	•		3-Panel	3-Panel	•	
FGI Airborne Isolation/ Pressurized Rooms		•	•					
Positive Latch Option	•	•	•		•	•	•	•
Electronic Fail-Safe Solenoid Lock				•				
Electronic Privacy Glass (EPG) Option	2-Panel	2-Panel	2-Panel		3-Panel	3-Panel		
Integral Blinds Option	•	•	•	•	•	•	•	•

▲ DURA-CARE™ 7000TL: 2 OR 4-PANEL MANUAL SLIDING DOOR



2-PANEL

Description: All panels break out to create a large opening when extra space is needed. Broad glass panels provide an unobstructed view to patients. Meets the “side hinge swinging” requirement for healthcare facilities.

Solution For: Patient privacy, frequent break out and reset, Smoke & Draft Rating Option

Breakout: Full Utility Breakout

Typical Frame Width: 2-panel: 84" - 108"; 4-panel: 120"-168"

[More Information](#)

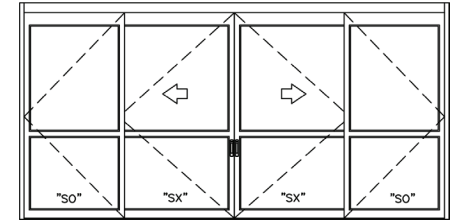

4-PANEL

▲ DURA-CARE™ 7200: 2-PANEL, 4-PANEL, or P-PANEL MANUAL SLIDING DOOR

Description: Emergency partial breakout door system. Available in surface-applied or standard two and four panel within-wall mount applications.

Solution For: Narrow opening with single or double surface-applied door panels, patient privacy, Smoke & Draft Rating Option (2-panel and P-Panel), Isolation Package (2-panel and P-Panel)

Breakout: Emergency Egress Partial Breakout

Typical Frame Width: 2-panel: 84" - 108"; 4-panel: 120"-168"

[More Information](#)



P-PANEL

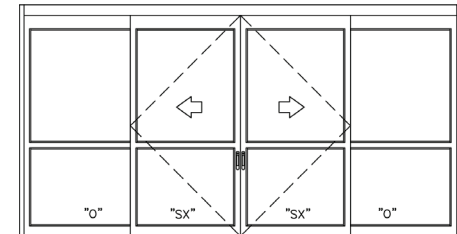

4-PANEL

▲ DURA-CARE™ 7300TL-FBO: 2-PANEL MANUAL SLIDING DOOR

Description: When panels are slid to full open position and a larger opening is needed, both panels swing open for easy transport of patients and equipment. Narrow jambs allow for large clear door openings.

Solution For: Smoke & Draft Rating Option, Isolation Package

Breakout: Full Utility Breakout

Typical Frame Width: 84" - 108"

[More Information](#)

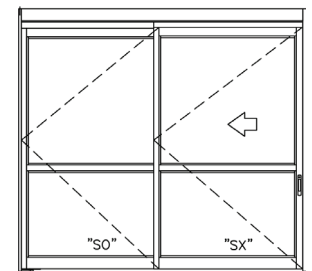

▲ DURA-CARE™ 7500A: SYNCHRONIZED 3-PANEL TELESCOPING AUTOMATIC DOOR



Description: 3-panel automatic sliding door with jamb-mounted touchless wave activation and overhead safety sensors.

Solution For: Patient privacy, wider clear door opening, frequent breakaway for patient transport

Breakout: Full Utility Breakout

Typical Frame Width: 84" - 108"

[More Information](#)

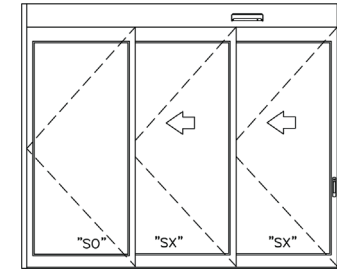

▲ DURA-CARE™ 7500TL: 3-PANEL, 6-PANEL, OR P-PANEL TELESCOPING MANUAL DOOR



Description: Emergency partial breakout door system. Available in surface-applied or standard 3-panel and 6-panel within-wall mount applications.

Solution For: Narrow openings with two or four surface-applied door panels, patient privacy, Smoke & Draft Rating Option (3-Panel)

Breakout: Emergency Egress Partial Breakout

Typical Frame Width: 3-panel: 84"-108"; 6-panel: 120"-168"

[More Information](#)

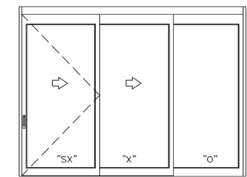

3-PANEL

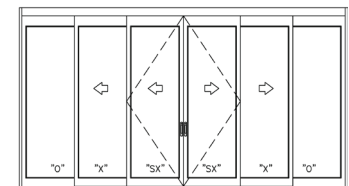

6-PANEL

▲ DURA-CARE™ 7500TL-FBO: 3-PANEL OR 6-PANEL TELESCOPING MANUAL DOOR



Description: When panels are slid to full open position and a larger opening is needed, all panels swing open for easy transport of patients and equipment.

Solution For: Small patient rooms, patient privacy, Smoke & Draft Rating Option (3-Panel)

Breakout: Full Utility Breakout

Typical Frame Width: 3-panel: 84"-108"; 6-panel: 120"-168"

[More Information](#)

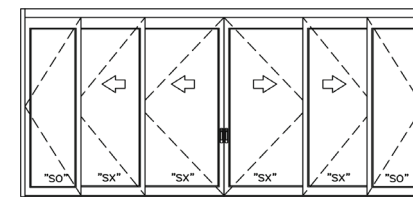

6-PANEL

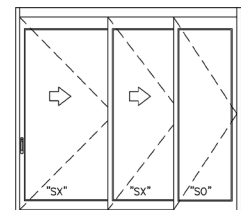

3-PANEL

▲ DURA-CARE™ 7400 SWING: SINGLE, PAIR, OR UNEVEN PAIR MANUAL SWING DOOR

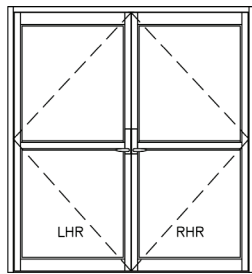

PAIR

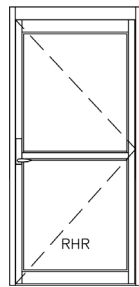

SINGLE

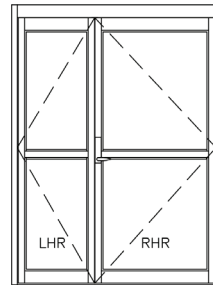

UNEVEN PAIR



Description: The Dura-Care™ 7400 Manual Swing Door System comes in single, pair or uneven pair configurations with a heavy-duty continuous hinge and built-in concealed closer. Choose from two header options to maintain sight lines when varying door types are used.

Solution For: Narrow openings and standard swing door location needs.

Breakout: Full Utility Breakout

Typical Frame Width: Pair: 75.5"- 99.5"; Single: 39.5"- 51.5"; Uneven Pair: 63.5"- 75.5"

[More Information](#)

▲ DURA-CARE™ 7600: 3-PANEL HYBRID SWING/FOLD DOOR SYSTEM



Description: Combines bi-directional manual swing door and a 2-panel manual bi-fold door in one continuous header. The bi-fold panels can be designed to either fold in or fold out and fully swing open (breakout) when more space is needed. Door closer ensures door closes securely. Includes built-in hold open at 105 degrees.

Solution For: Small rooms requiring frequent patient transfers.

Breakout: Full Utility Breakout

Typical Frame Width: 84"-120"

[More Information](#)

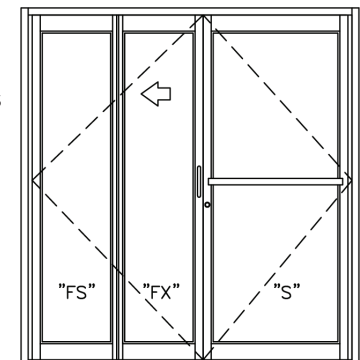

3-PANEL



Automatic Sliding Doors

Our highly customizable automatic sliding doors are designed to provide the versatility and durability necessary to meet the unique demands of healthcare environments. These doors ensure compliance with ADA standards, CDO requirements for a wide range of entrances, and applicable fire, life safety, and building codes. Available in a diverse range of models, our automatic sliding doors cater to specific needs, including hurricane-rated, blast-resistant, energy-efficient, all-glass, and telescoping options.

The adaptability of STANLEY automatic sliding doors makes them an ideal solution for healthcare settings, where emergency egress and the ability to accommodate heavy foot traffic are crucial. Whether enhancing safety, efficiency, or accessibility, our sliding doors provide reliable performance and peace of mind in even the most demanding medical facilities.

SELECTION GUIDE

AUTOMATIC SLIDING/TELESCOPING DOORS

The products listed in the selection guide are suggestions only. Reach out to your local STANLEY Spec Writer to discuss your specific project requirements.

Features	Dura-Glide® 2000/3000 Standard	Dura-Glide® 2000/3000 All Glass	Dura-Glide® 2000/3000 Clean Room	Dura-Glide® 2000/3000 GreenStar	Dura-Storm™ 2000/3000 Impact Rated	Dura-Storm™ 2000/3000 Non-Impact	Dura-Shield™ Blast-Rated	Dura-Glide® 5200/5300 Telescoping	DuraFit™ Telescoping
Air Infiltration Tested (ASTM E283)				•	•	•			
Panel Closer/ Magnetic Latch Option				•					
Welded Panels					•	•	•		
Clean Room Certified			•					•	
No Threshold Option	• 2000 only	• 2000 only	• 2000 only					• 5200 only	•
Transom Option	•	•	•	•		•		•	•
Wind Pressure Rated					•	•			
Impact Rated Door and Glazing					•				
ASTM F2927 and UFC 04-01-01 Blast Compliance							•		

▲ DURA-GLIDE® 2000/3000: AUTOMATIC SLIDING DOOR

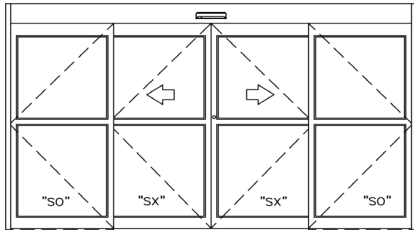

3000 BI-PART

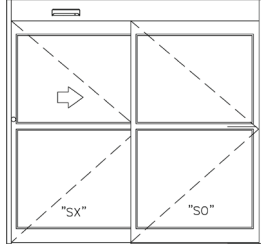

3000 SINGLE SLIDE

Description: With the highest horsepower in the industry, the Dura-Glide® 2000/3000 is known for its reliable operation in high traffic, interior and exterior healthcare applications. Can meet 72" CDO requirement for ambulance entrances, compliant with ADA and other fire, life safety and building codes, panels breakout for emergency egress.

Breakout: Full Emergency Breakout (3000) or Partial Breakout (2000)

Typical Frame Width: Single Slide: 84"-108" | Bi-Part: 120"-168"

Glazing: 1/4" or 1/2" monolithic; 5/8" or 1" insulated"



[More Information](#)

▲ DURA-GLIDE® 2000/3000 ALL GLASS: ALL GLASS AUTOMATIC SLIDING DOOR



Description: The Dura-Glide® All Glass doors and sidelights are expertly crafted to seamlessly integrate into building designs, offering a sleek and modern aesthetic. These doors can meet the 72" CDO requirement for ambulance entrances and feature an emergency breakaway function that provides expansive openings when necessary. Designed to accommodate 1/2" tempered glass with polished edges, the Dura-Glide® All Glass doors ensure both style and functionality.

Breakout: Full Emergency Breakout (3000) or Partial Breakout (2000)

Typical Frame Width: Single Slide: 84"-102" | Bi-Part: 120"-168"

Glazing: 1/2" monolithic

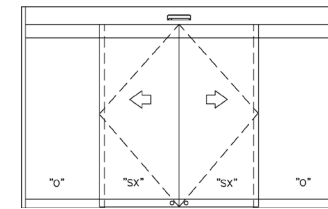

2000 BI-PART

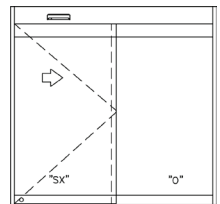

2000 SINGLE SLIDE

[More Information](#)

▲ DURA-GLIDE® 2000/3000 GREENSTAR: ENERGY EFFICIENT AUTOMATIC SLIDING DOOR



Description: The Dura-Glide® GreenStar is designed to deliver enhanced energy efficiency and performance, meeting ASTM E283 standards to minimize energy loss through reduced air infiltration. This innovative door solution offers superior thermal performance, can comply with the 72" CDO requirement for ambulance entrances, and features breakout panels for reliable emergency egress.

Breakout: Full Emergency Breakout (3000) or Partial Breakout (2000)

Typical Frame Width: Single Slide: 84"-108" | Bi-Part: 120"-168"

Glazing: 1/4" or 1/2" monolithic; 5/8" or 1" insulated"

1" insulated Low-E Glass is suggested when trying to achieve certain U-values

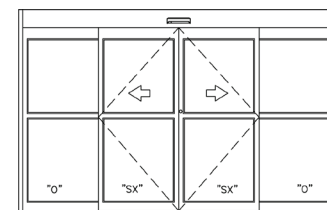

2000 BI-PART

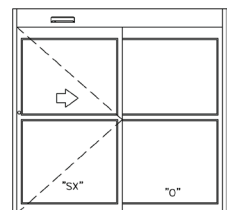

2000 SINGLE SLIDE

[More Information](#)

DURA-STORM™ 2000/3000: HURRICANE-RATED AUTOMATIC SLIDING DOOR

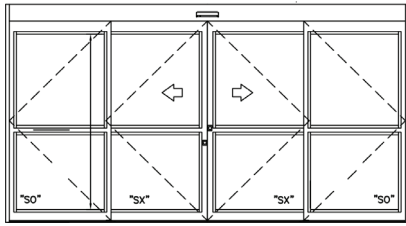

3000 BI-PART
IMPACT LEVEL D

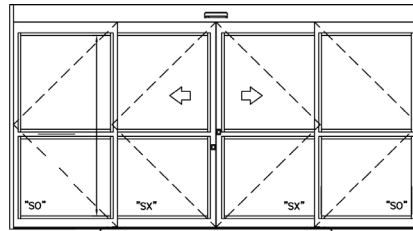

3000 BI-PART
IMPACT LEVEL E

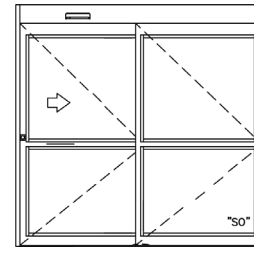

3000 SINGLE SLIDE
IMPACT LEVEL D

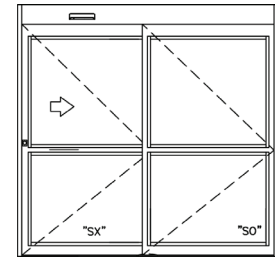

3000 SINGLE SLIDE
IMPACT LEVEL E

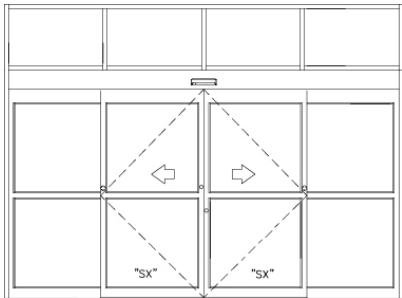

2000 BI-PART
NON-IMPACT W/ TRANSOM

Description: As your first line of defense from hurricanes, the Dura-Storm™ withstands high wind pressure, protecting against wind-borne debris, and providing improved energy efficiency. Tested to withstand winds up to 80 PSF and the impact of flying debris, welded panels and reinforcements keep panels on track, reduce door damage and increase protection. Complies with FL Building Code, Miami-Dade NOA Code, and ASTM E283.

Breakout: Full Emergency Breakout (3000) or Partial Breakout (2000)

Typical Frame Width: Impact Rated: Single Slide: 84"-108" Bi-Part: 120"-168"
Impact Rated with Steel Reinforcement: Single Slide: 84"-108", Bi-Part: 120"-192"
Non-Impact: Single Slide: 84"-108" Bi-Part: 120"-168" with optional transom to 123 3/4"

Glazing: Impact Level D Rated: 9/16" laminated, 1 1/8" laminated/insulated
Impact Level E Rated: 5/8" laminated
Non-Impact Rated: 1/4", 1" insulated



[More Information](#)

DURA-SHIELD™: BLAST-RESISTANT AUTOMATIC SLIDING DOOR

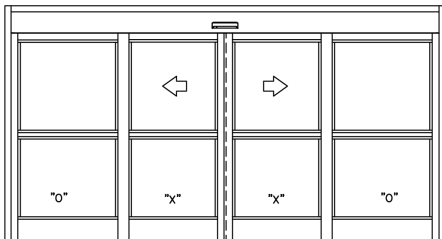

2000 BI-PART



SINGLE SLIDE

Description: The Dura-Shield™ Blast-Resistant Door provides the utmost protection from blast attacks, providing solid performance and security. Complies with DOD UFC & ATFP 4-010-01 requirements. The Dura-Shield™ Blast Door is engineered to provide exceptional protection against blast threats, achieving ASTM Category III and ASTM Glazing Hazard H1/H2 ratings.

Blast Breakout: Non-breakout

Typical Frame Width: Single Slide 96"-120" Bi-Part 120"-192"

Glazing: Laminated-insulated blast-resistant glazing

[More Information](#)

Telescoping Doors



▶ DURAFIT™: 6-PANEL TELESCOPING AUTOMATIC DOOR



Description: Achieve the largest possible clear door opening for 6' - 9' package width with the DuraFit™. Panels are synchronized for a smooth and fast opening to keep staff and patients moving.

Breakout: Full Emergency Breakout

Typical Frame Width: 71.5" - 108"

Glazing: Factory Installed; 1-1/4" insulated

[More Information](#)

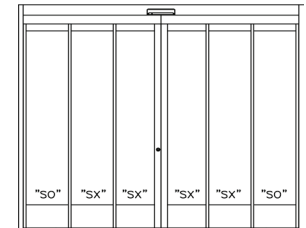

▶ DURA-GLIDE® 5200/5300: 3 OR 6-PANEL TELESCOPING AUTOMATIC DOOR

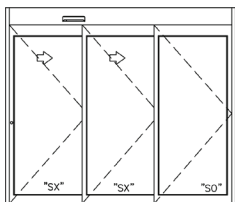

5300 3-PANEL

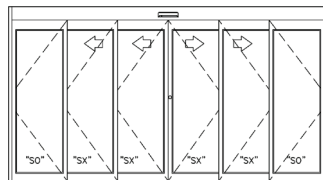

5300 6-PANEL

Description: Automatic telescoping doors create a large clear door opening when space is limited, opening 25% wider than 2 and 4-panel automatic sliding doors. 3-or 6-panel options available.

Features: Full Emergency Breakout (5300) or Partial Emergency Breakout (2000)

Typical Frame Width: 3-panel 72"-144", 6-pane 108"-168"

Glazing: 1/4" or 1/2" monolithic, 5/8" insulated, 1" insulated (5200 only)

[More Information](#)



Swing Door Operators

Automatic swing door operators offer a flexible and efficient solution for automating both new and existing manual swing doors, significantly enhancing convenience, accessibility, and compliance with accessibility standards.

Customers can choose between Low Energy configurations, activated by touchless wave plates or push plates, and Full Energy configurations, which utilize motion sensors for automatic operation. Depending on the specific door requirements, these operators can handle door panels weighing up to 700 lbs, making them suitable for both lightweight and heavy-duty applications.

Swing door operators are fully compliant with U.S. and Canadian accessibility laws, ensuring ADA compliance and hands-free operation for enhanced usability. They can interface seamlessly with a variety of access control systems, including keypads, card readers, and key switches, providing added security and convenience.

Models:

- Full Energy (FE) fully automatic per ANSI/BHMA A156.10
- Low Energy (LE) with knowing-act activation per ANSI/BHMA A156.19

M-FORCE™: HEAVY DUTY SWING DOOR OPERATOR



Description: The M-Force™ swing door operator can automate any new or existing door. This versatile operator can be configured as low energy (LE) on door panels up to 700lbs, or full energy (FE.)

Solution For: Facilities prioritizing accessibility, safety, and swift and efficient passage, including but not limited to corridor doors, lead-lined doors.

Activation Options: Low energy (LE) activation options include push plates, touchless wave plates, or access control devices such as key pads, card readers, or key switches. Full Energy (FE) swing door operators are fully automated through motion activation such as overhead sensor activation, and optional knowing act device activation.

ADA Compliance: ANSI/BHMA A156.19 for Low Energy or ANSI/BHMA A156.10 for Full Energy

[More Information](#)

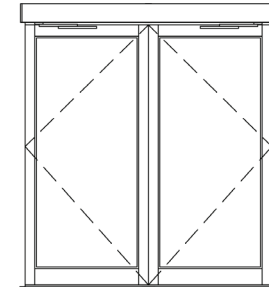

PAIR

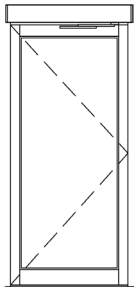

SINGLE

MAGIC ACCESS™: LOW ENERGY SWING DOOR OPERATOR



Description: The Magic-Access™ low energy swing door operator is designed to provide a quiet, smooth, and safe solution for automating swing doors. This swing door operator can automate new or existing swing door panels up to 125 pounds, 42" width. May be surface mount or overhead concealed. Available as fire door package with UL listed equipment.

Activation Options: Low energy (LE) activation options include push plates, touchless wave plates, or access control devices such as key pads, card readers, or key switches.

Solution For: Ideal for corridor restrooms, areas requiring card access, and for facilities prioritizing accessibility, safety, and operational efficiency.

ADA Compliance: ANSI/BHMA A156.19 for Low Energy

[More Information](#)

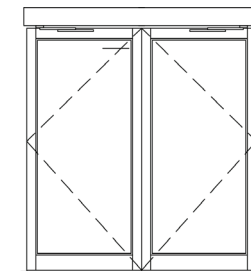

PAIR

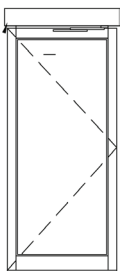

SINGLE



WITH NEARLY
100
YEARS OF EXPERIENCE
AND DEDICATION

THE STANLEY DIFFERENCE

We are reliable to our core because you depend on us.

Even though we already have the largest geographic footprint in North America, we are continuously expanding our team of Research & Development and innovation engineers, sales representatives and service and install technicians. This paired with being the only manufacturer with two US factories means you can trust us to get what you need, how you need it and when you need it.

We never cut corners when it comes to safety and compliance.

Excellence is equated to making it right the first time, because we know every expertly crafted product we make needs to help you do better, safer, more significant work. Our unwavering mission to adhere to the highest standards of material, workmanship and service since we invented the first swinging automatic door over 90 years ago is the reason we continue to be the industry leader.

Experience and dedication to take you from where you are to where you want to go.

Our job is to help you do yours better, and we take pride in what you make possible. So you get consistency that meets your complete satisfaction, our products are only sold by, shipped by, handled by and installed by dedicated STANLEY employees and partners. Their experience with product solutions, codes and standards, and the industry runs deep; with an average of 12 years for our technicians and 13 years for our sales representatives.

We are a Purpose-driven organization. This is what binds us and drives us to do the impossible. **Together, we can Make The World Accessible.**

DOOR SERVICE MADE SIMPLE



DOORS ARE NOT YOUR MOST CRITICAL PIECE OF HEALTHCARE EQUIPMENT. BUT WE SERVICE THEM AS IF THEY WERE.

As a service customer, you will receive the expertise of the industry's largest and most experienced automatic door service provider in North America. You can be assured your equipment is kept in top operating condition, planned service is completed as required, parts replacement meet manufacturer's specification, and all activity is appropriately documented thereby minimizing your liability exposure.

We help make the world accessible.

More than 90 years ago, STANLEY Access Technologies invented the world's first swinging automatic door, and we continue to innovate to this day. We focus on how people use access points in the real world to explore solutions built on integrity, dependability, access, confidence and connections.

- Expertly designed and engineered ICU door systems
- Wide range of customizable solutions developed in partnership with healthcare professionals put patient safety, privacy and comfort first
- Compliant with ADA and other fire, life safety and building codes
- Emergency and Utility breakout
- Enhanced security integration options
- Adhere to the highest standards of service, workmanship and materials
- Largest service network in North America



STANLEY®

Access Technologies

ALLEGION™ 
An Allegion Brand

CONTACT

StanleyAccess.com

1-800-7-ACCESS

Service: 1-888-DOOR-444

SAT-0167 Rev. 11/25

