

STANLEY
Access Technologies

DURA-GLIDE
5200
SERIES

6-PANEL TELESCOPIC WITH OPTIONAL TRANSOM

PROJECT INFORMATION

PROJECT NAME:

LOCATION:

DOOR NUMBER(S):

DATE:

SHEET: OF

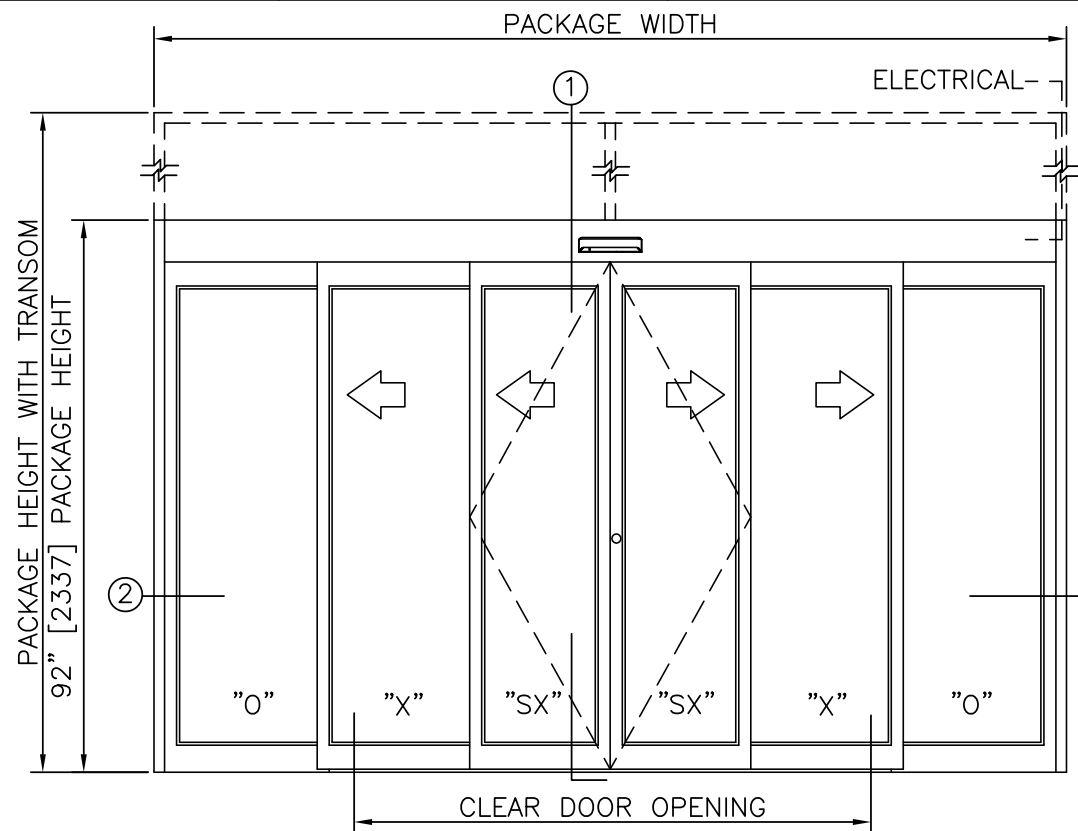

ELEVATION VIEW
SCALE: 3/8" = 1'-0"

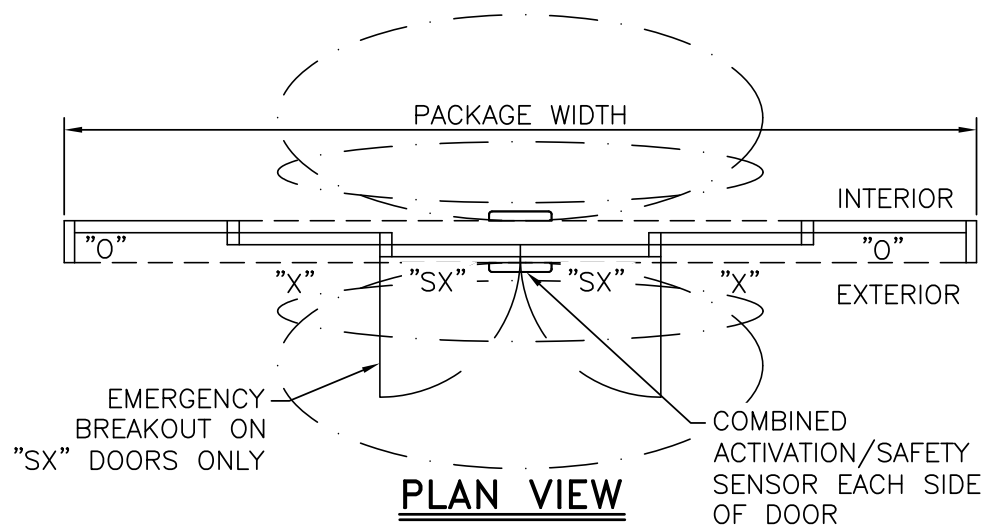

PLAN VIEW
SCALE: 3/8" = 1'-0"

NOTES

1. ELECTRICAL REQUIREMENTS: 120 VAC, 5 AMP MIN TO POWER OPERATOR BY ELECTRICAL CONTRACTOR.
2. ROUGH OPENING SHALL PROVIDE 1/4"[6] SHIM SPACE ON SIDES AND TOP OF PACKAGE.
3. LIMITS OF ACTIVATION AND SAFETY ZONES ARE FOR REFERENCE ONLY; SEE ANSI/BHMA A156.10 FOR DETAILED REQUIREMENTS.
4. STANDARD LOCKING IS 2-POINT; 3-POINT AND ACCESS CONTROL SYSTEMS AVAILABLE. SEE SHEET 1.61.
5. STANDARD GLAZING STOPS FOR SLIDING AND FIXED PANELS ARE 1/4"[6]; 5/8"[16] AND 1"[25] AVAILABLE.
6. STANDARD STILES AND BOTTOM RAILS SHOWN; MEDIUM STILES, BOTTOM RAILS TO 12"[305], AND MUNTINS AVAILABLE.
7. SEE SPECIFICATIONS FOR ADDITIONAL INFORMATION.

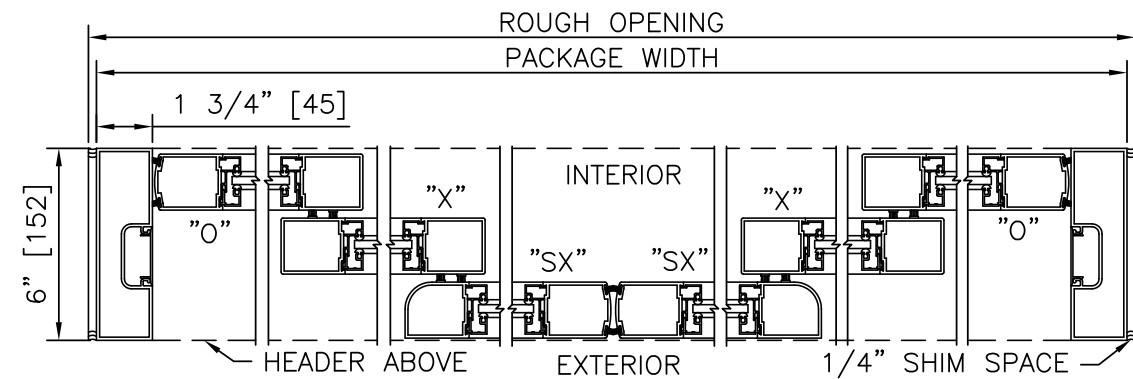

2 HORIZONTAL SECTION
SCALE: 2" = 1'-0"

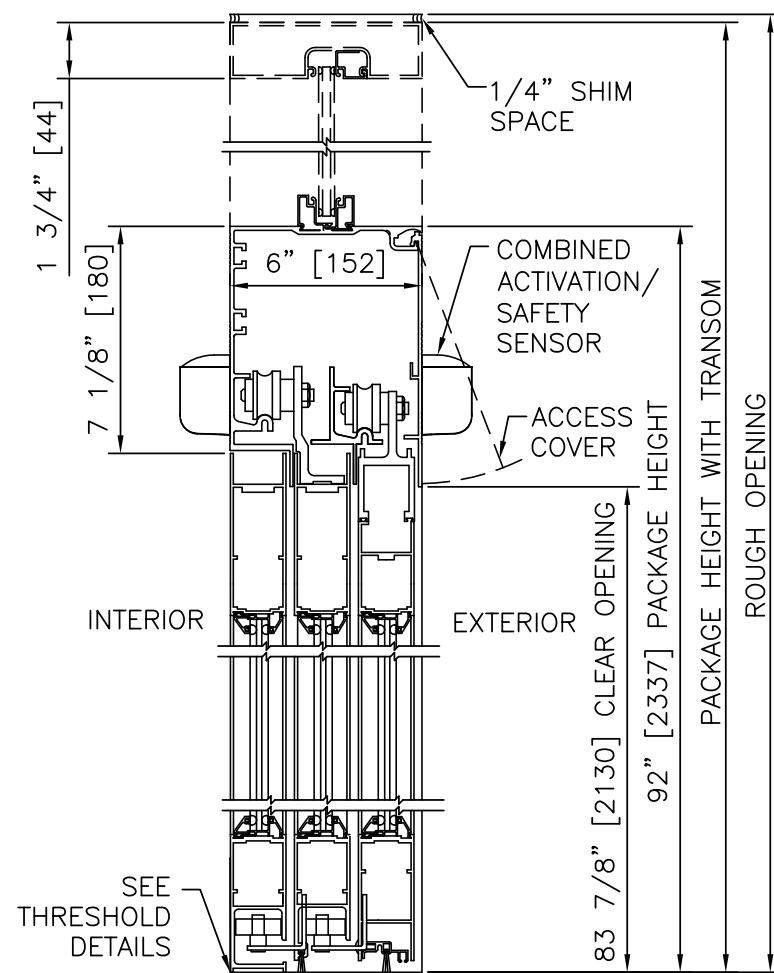

1 VERTICAL SECTION
SCALE: 2" = 1'-0"

PRODUCT OPTIONS

- TRANSOM
 YES
 VERTICALS 1 2 3 4 5
- FINISH
 ANODIZED CLEAR CL2
 ANODIZED DK BRONZE
 CUSTOM
- LOCKING
 2-POINT
 ACCESS CONTROL (PANIC)
 3-POINT
- STILES
 NARROW
 MEDIUM
- BOTTOM RAILS
 STANDARD 4"
 OPTIONAL 6" 8" 10" 12"
- THRESHOLDS
 NONE
 DBL BVL
 RECESSED
- ACTIVATION/SAFETY
 2 COMBINED ACTIVATION/SAFETY SENSORS
- OTHER OPTIONS
 ROTARY CTRL SWITCH
 UNINTERRUPTIBLE POWER SUPPLY
 FLY OPEN BOX
 ALARM CONTACTS
 CLEAN ROOM (CL 10)

6-PANEL TELESCOPIC FORMULAS - NARROW STILE
 PACKAGE WIDTH = 3/2 CLEAR DOOR OPENING + 30.7"
 CLEAR DOOR OPENING = 2/3 PACKAGE WIDTH - 20.5"
 EMERGENCY BREAKOUT WIDTH = 2 X DOOR PANEL WIDTH - 5.1"
 DOOR PANEL WIDTH (SX, O) = 1/6 PACKAGE WIDTH + 1.1"
 DOOR PANEL WIDTH (X) = 1/6 PACKAGE WIDTH + 1.0"

6-PANEL TELESCOPIC FORMULAS - MEDIUM STILE
 PACKAGE WIDTH = 3/2 CLEAR DOOR OPENING + 42.7"
 CLEAR DOOR OPENING = 2/3 PACKAGE WIDTH - 28.5"
 EMERGENCY BREAKOUT WIDTH = 2 X DOOR PANEL WIDTH - 8.3"
 DOOR PANEL WIDTH (ALL) = 1/6 PACKAGE WIDTH + 2.1"

TYPICAL PACKAGE DIMENSIONS (NARROW STILE)			
PACKAGE WIDTH	NOMINAL CLEAR DOOR OPENING	SLIDING DOOR PANEL NOMINAL WIDTH	EMERGENCY BREAKOUT NOM. WIDTH
120"	59.5"	21.0"	37.1"
144"	75.5"	25.0"	45.1"
168"	91.5"	29.0"	53.1"

6-PANEL TELESCOPIC WITH OPTIONAL TRANSOM

DURA-GLIDE
5200
SERIES

STANLEY
Access Technologies

**DURA-GLIDE
5200
SERIES**

6-PANEL TELESCOPIC

PROJECT INFORMATION

PROJECT NAME:

LOCATION:

DOOR NUMBER(S):

DATE:

SHEET: OF

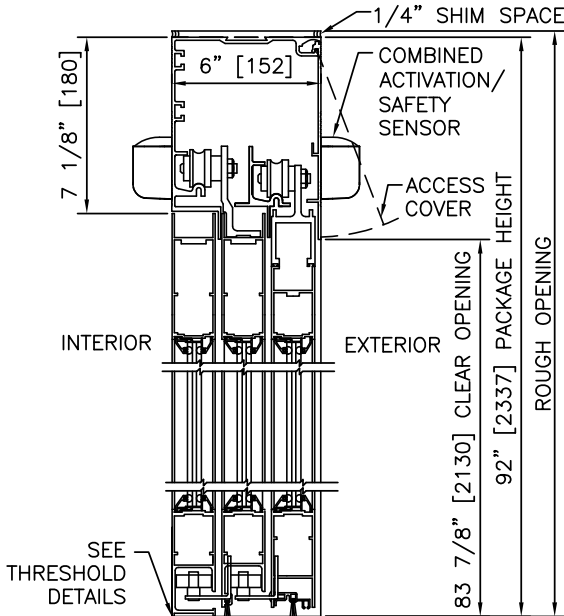

① VERTICAL SECTION

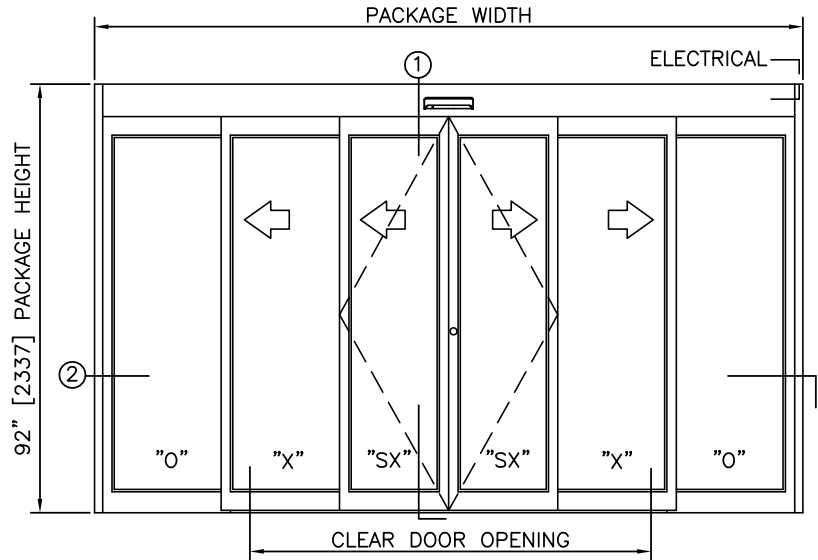

ELEVATION

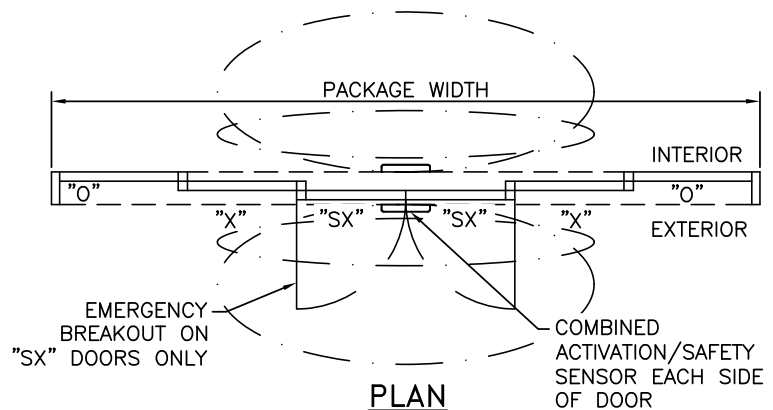

PLAN

NOTES

1. ELECTRICAL REQUIREMENTS: 120 VAC, 5 AMP MIN TO POWER OPERATOR BY ELECTRICAL CONTRACTOR.
2. ROUGH OPENING SHALL PROVIDE 1/4\"/>

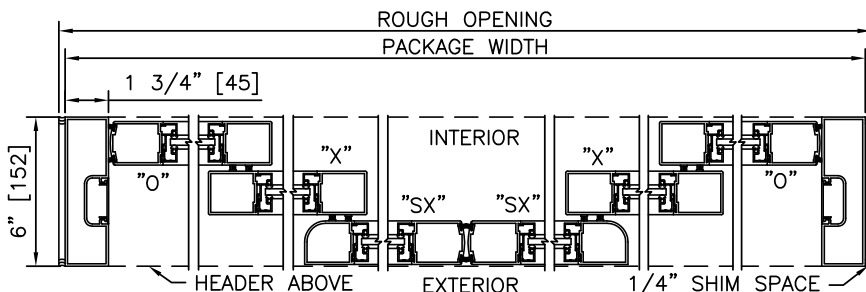

② HORIZONTAL SECTION

TYPICAL PACKAGE DIMENSIONS (NARROW STILE)

PACKAGE WIDTH	NOMINAL CLEAR DOOR OPENING	SLIDING DOOR PANEL NOMINAL WIDTH	EMERGENCY BREAKOUT NOM. WIDTH
120"	59.5"	21.0"	37.1"
144"	75.5"	25.0"	45.1"
168"	91.5"	29.0"	53.1"

**DURA-GLIDE
5200
SERIES**

6-PANEL TELESCOPIC WITH TRANSOM

PROJECT INFORMATION

PROJECT NAME:

LOCATION:

DOOR NUMBER(S):

DATE:

SHEET: OF

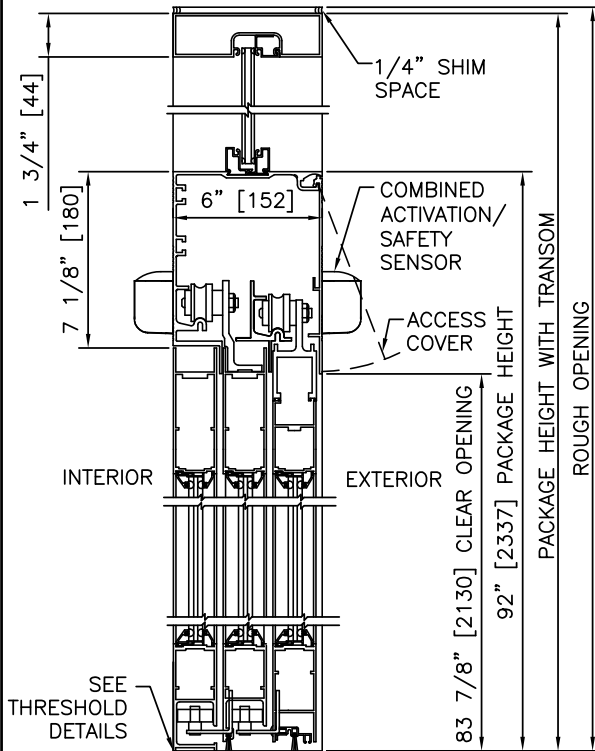

1 VERTICAL SECTION

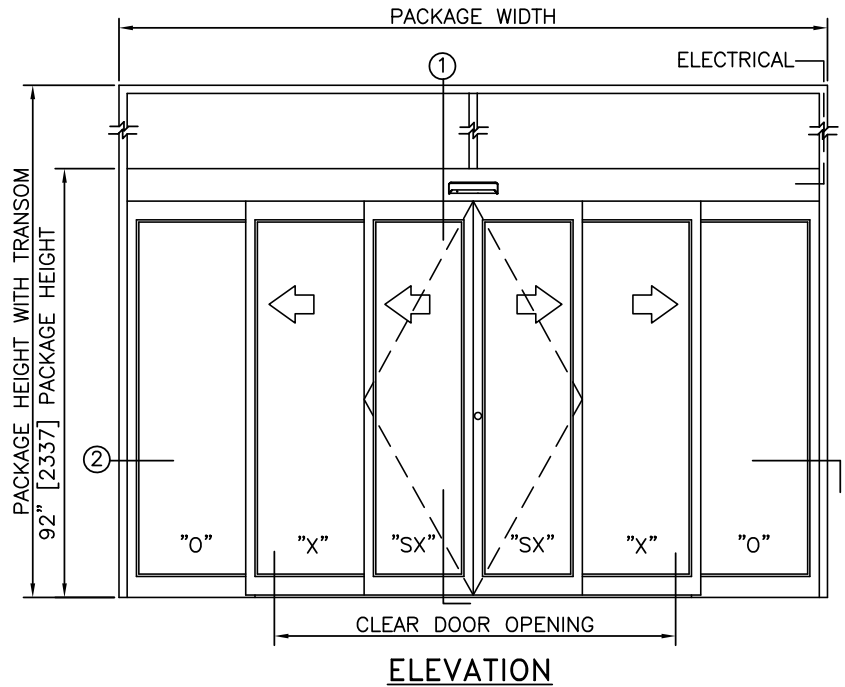

ELEVATION

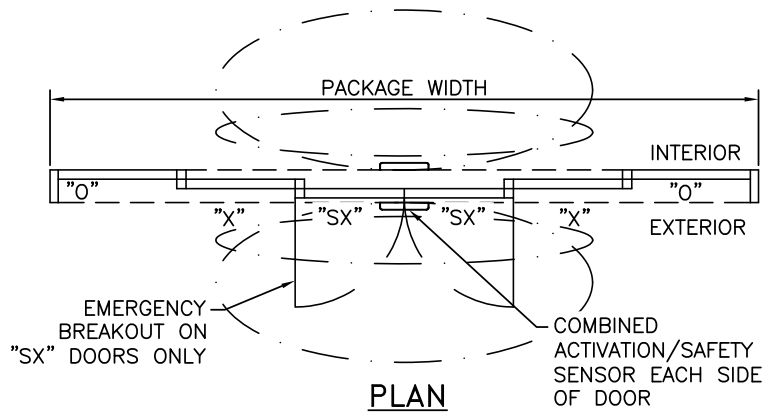

PLAN

NOTES

1. ELECTRICAL REQUIREMENTS: 120 VAC, 5 AMP MIN TO POWER OPERATOR BY ELECTRICAL CONTRACTOR.
2. ROUGH OPENING SHALL PROVIDE 1/4\"[6] SHIM SPACE ON SIDES AND TOP OF PACKAGE.
3. LIMITS OF ACTIVATION AND SAFETY ZONES ARE FOR REFERENCE ONLY; SEE ANSI/BHMA A156.10 FOR DETAILED REQUIREMENTS.
4. SEE SPECIFICATIONS FOR ADDITIONAL INFORMATION.

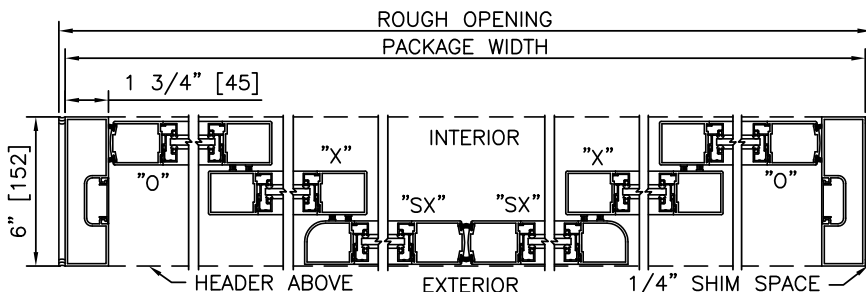

2 HORIZONTAL SECTION

TYPICAL PACKAGE DIMENSIONS (NARROW STILE)

PACKAGE WIDTH	NOMINAL CLEAR DOOR OPENING	SLIDING DOOR PANEL NOMINAL WIDTH	EMERGENCY BREAKOUT NOM. WIDTH
120"	59.5"	21.0"	37.1"
144"	75.5"	25.0"	45.1"
168"	91.5"	29.0"	53.1"

**DURA-GLIDE
5200
SERIES**

6-PANEL TELESCOPIC WITH ACCESS CONTROL, SURFACE

PROJECT INFORMATION

PROJECT NAME:

LOCATION:

DOOR NUMBER(S):

DATE:

SHEET: OF

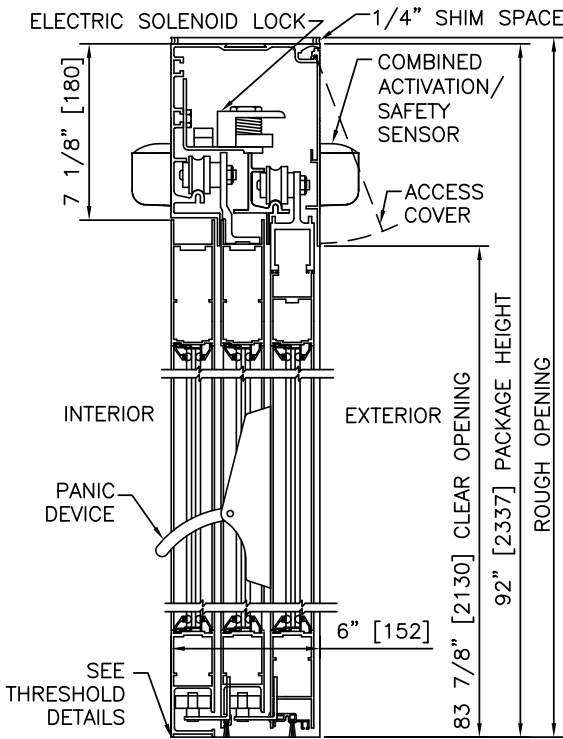

1 VERTICAL SECTION

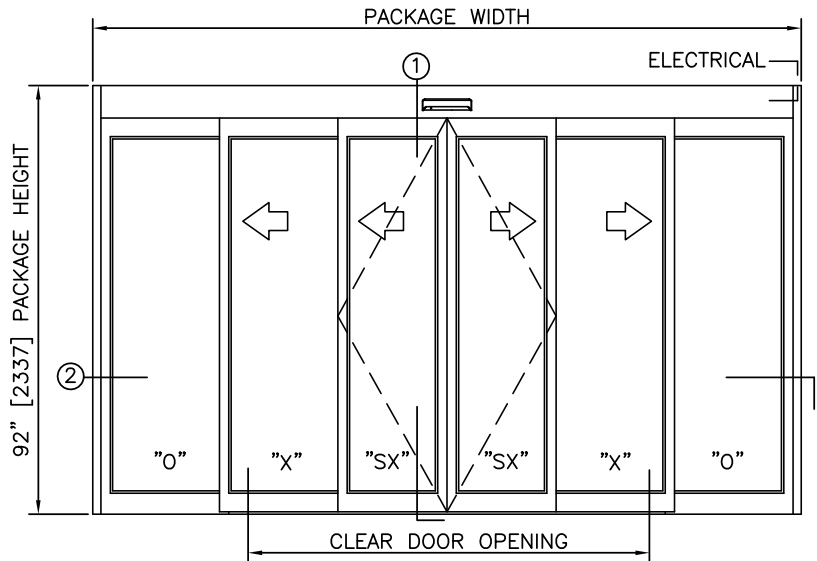

ELEVATION

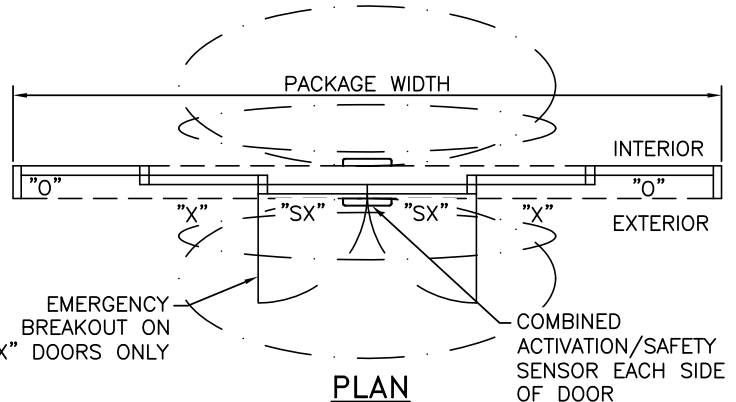

PLAN

NOTES

1. ELECTRICAL REQUIREMENTS: BY ELECTRICAL CONTRACTOR 120 VAC, 5 AMP MIN TO POWER OPERATOR CONTROL CIRCUIT FROM SECURE ACTIVATION TO OPERATOR
2. ROUGH OPENING SHALL PROVIDE 1/4" [6] SHIM SPACE ON SIDES AND TOP OF PACKAGE.
3. LIMITS OF ACTIVATION AND SAFETY ZONES ARE FOR REFERENCE ONLY; SEE ANSI/BHMA A156.10 FOR DETAILED REQUIREMENTS.
4. SEE SPECIFICATIONS FOR ADDITIONAL INFORMATION.

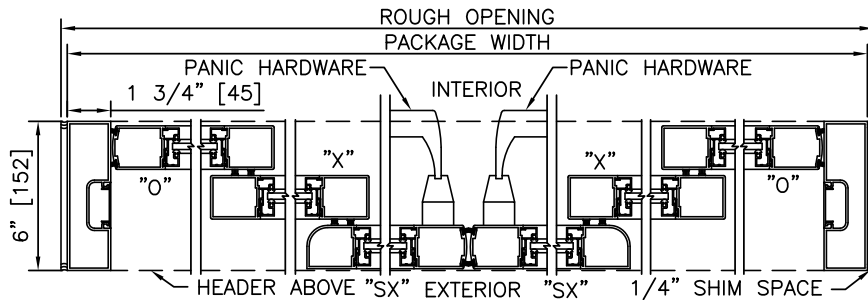

2 HORIZONTAL SECTION

TYPICAL PACKAGE DIMENSIONS (NARROW STILE)

PACKAGE WIDTH	NOMINAL CLEAR DOOR OPENING	SLIDING DOOR PANEL NOMINAL WIDTH	EMERGENCY BREAKOUT NOM. WIDTH
120"	59.5"	21.0"	37.1"
144"	75.5"	25.0"	45.1"
168"	91.5"	29.0"	53.1"

**DURA-GLIDE
5200
SERIES**

6-PANEL TELESCOPIC WITH TRANSOM & ACCESS CONTROL, SURFACE

PROJECT INFORMATION

PROJECT NAME:

LOCATION:

DOOR NUMBER(S):

DATE:

SHEET: OF

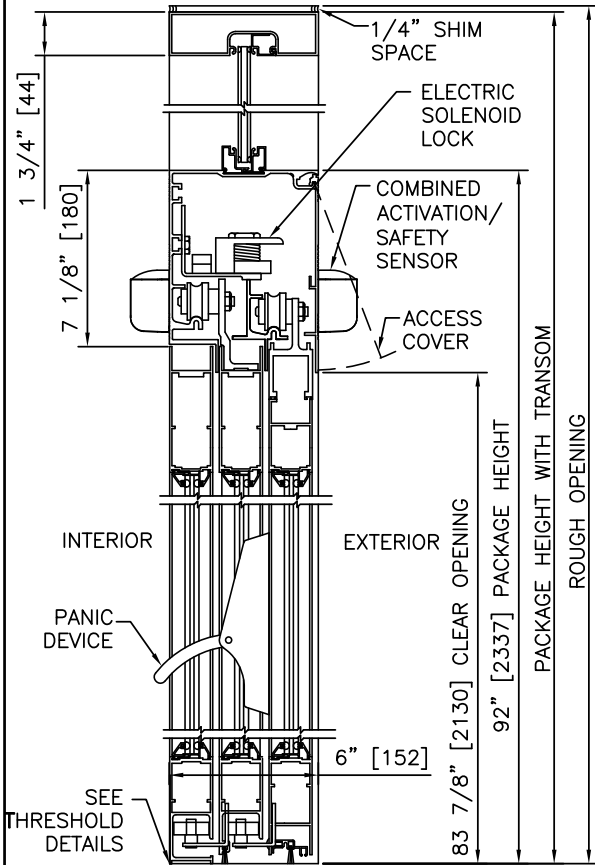

1 VERTICAL SECTION

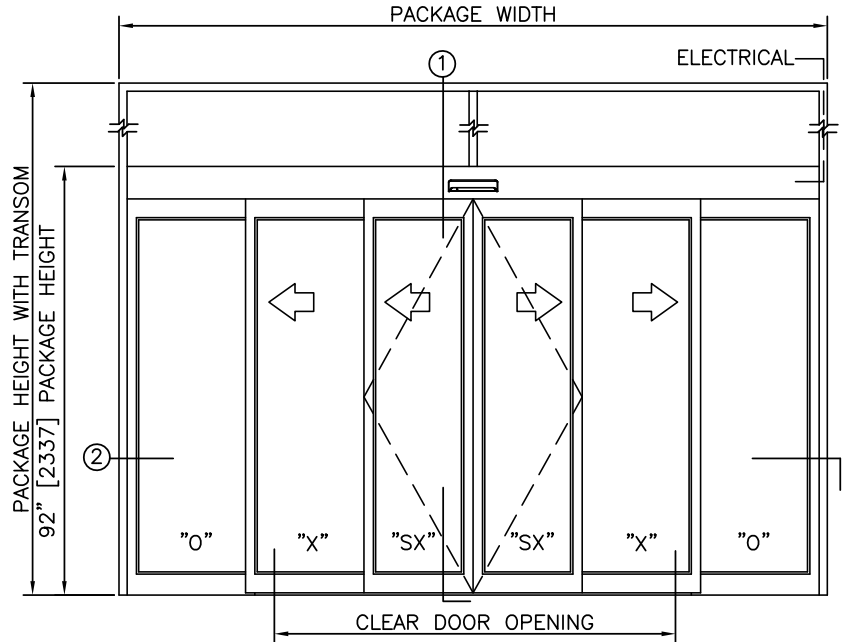

ELEVATION

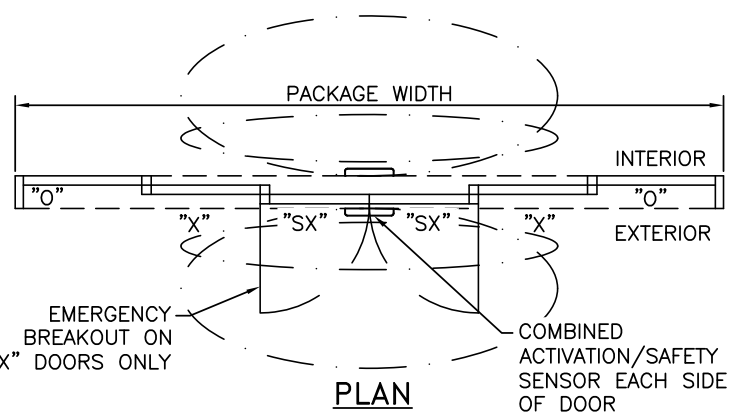

PLAN

NOTES

1. ELECTRICAL REQUIREMENTS: BY ELECTRICAL CONTRACTOR 120 VAC, 5 AMP MIN TO POWER OPERATOR CONTROL CIRCUIT FROM SECURE ACTIVATION TO OPERATOR
2. ROUGH OPENING SHALL PROVIDE 1/4" [6] SHIM SPACE ON SIDES AND TOP OF PACKAGE.
3. LIMITS OF ACTIVATION AND SAFETY ZONES ARE FOR REFERENCE ONLY; SEE ANSI/BHMA A156.10 FOR DETAILED REQUIREMENTS.
4. SEE SPECIFICATIONS FOR ADDITIONAL INFORMATION.

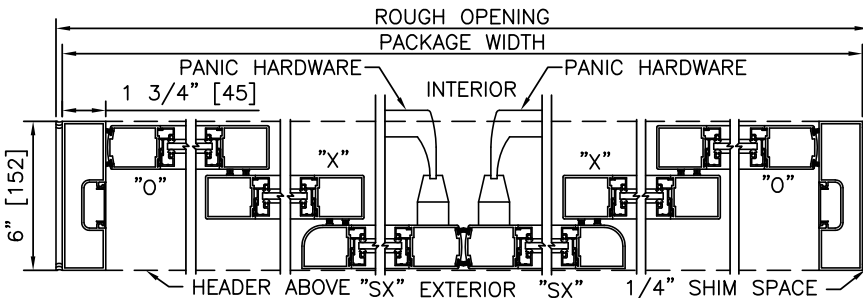

2 HORIZONTAL SECTION

TYPICAL PACKAGE DIMENSIONS (NARROW STILE)

PACKAGE WIDTH	NOMINAL CLEAR DOOR OPENING	SLIDING DOOR PANEL NOMINAL WIDTH	EMERGENCY BREAKOUT NOM. WIDTH
120"	59.5"	21.0"	37.1"
144"	75.5"	25.0"	45.1"
168"	91.5"	29.0"	53.1"

**DURA-GLIDE
5200
SERIES**

6-PANEL TELESCOPIC WITH ACCESS CONTROL, RECESSED

PROJECT INFORMATION

PROJECT NAME:

LOCATION:

DOOR NUMBER(S):

DATE:

SHEET: OF

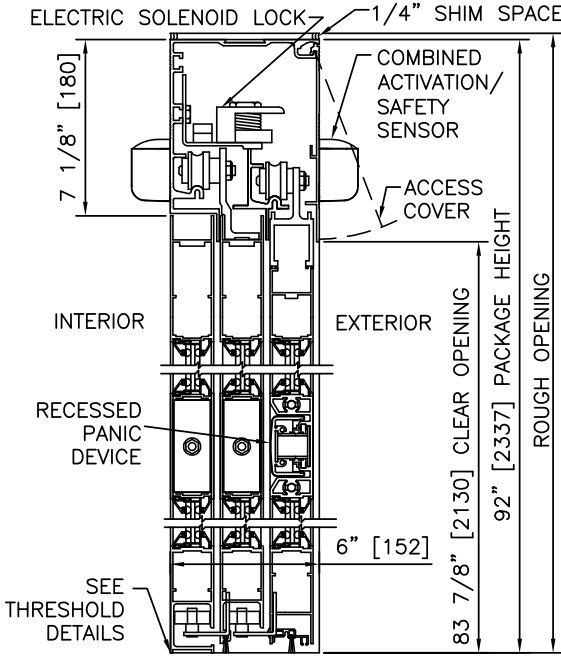

① VERTICAL SECTION

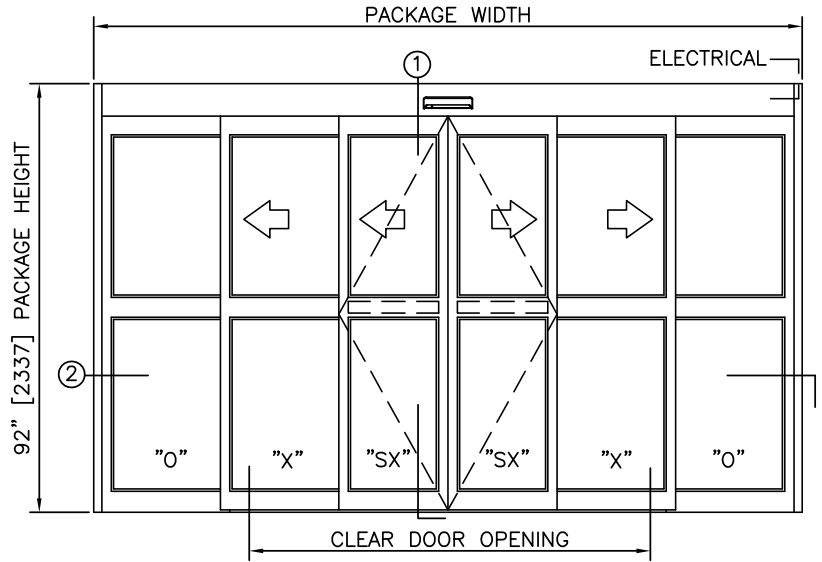

ELEVATION

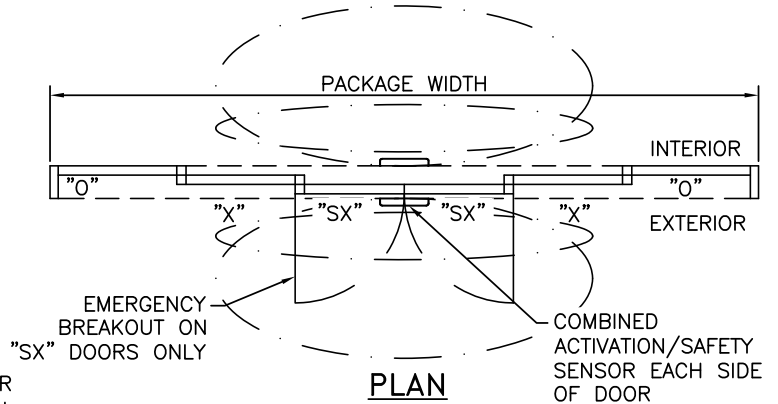

PLAN

NOTES

1. ELECTRICAL REQUIREMENTS: BY ELECTRICAL CONTRACTOR
120 VAC, 5 AMP MIN TO POWER OPERATOR
CONTROL CIRCUIT FROM SECURE ACTIVATION TO OPERATOR
2. ROUGH OPENING SHALL PROVIDE 1/4" [6] SHIM SPACE ON SIDES AND TOP OF PACKAGE.
3. LIMITS OF ACTIVATION AND SAFETY ZONES ARE FOR REFERENCE ONLY; SEE ANSI/BHMA A156.10 FOR DETAILED REQUIREMENTS.
4. SEE SPECIFICATIONS FOR ADDITIONAL INFORMATION.

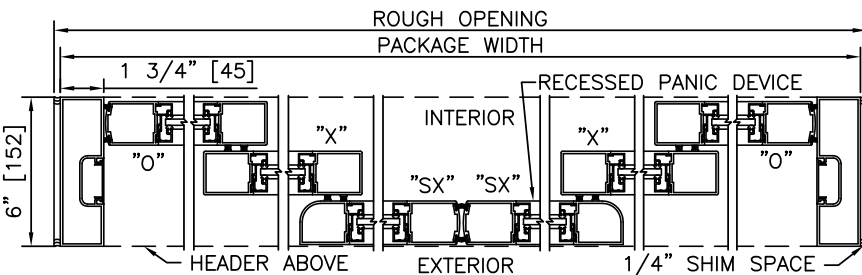

② HORIZONTAL SECTION

TYPICAL PACKAGE DIMENSIONS (NARROW STILE)

PACKAGE WIDTH	NOMINAL CLEAR DOOR OPENING	SLIDING DOOR PANEL NOMINAL WIDTH	EMERGENCY BREAKOUT NOM. WIDTH
120"	59.5"	21.0"	37.1"
144"	75.5"	25.0"	45.1"
168"	91.5"	29.0"	53.1"

**DURA-GLIDE
5200
SERIES**

6-PANEL TELESCOPIC WITH TRANSOM & ACCESS CONTROL, RECESSED

PROJECT INFORMATION

PROJECT NAME:

LOCATION:

DOOR NUMBER(S):

DATE:

SHEET: OF

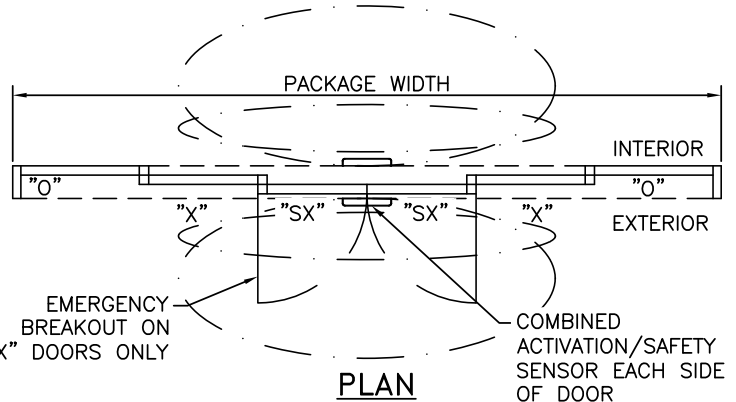
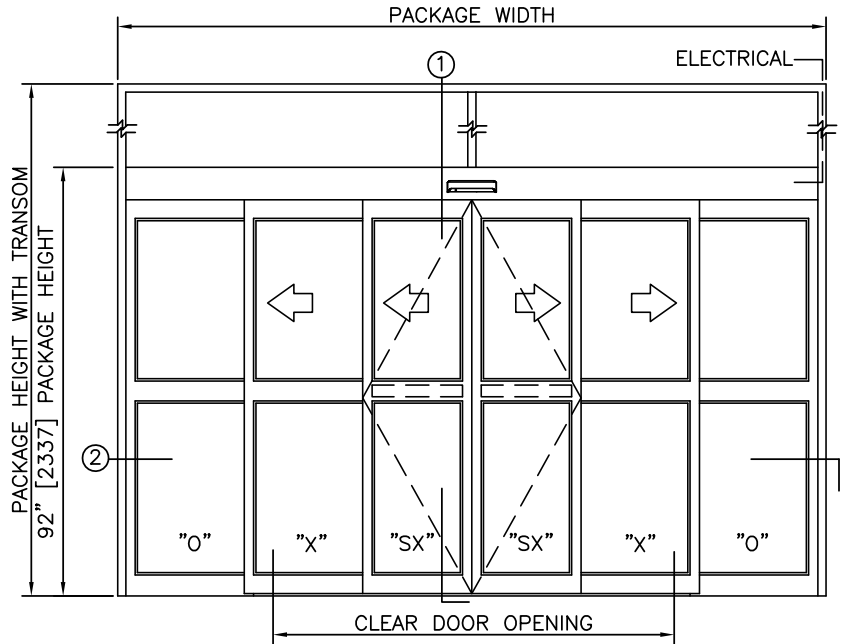
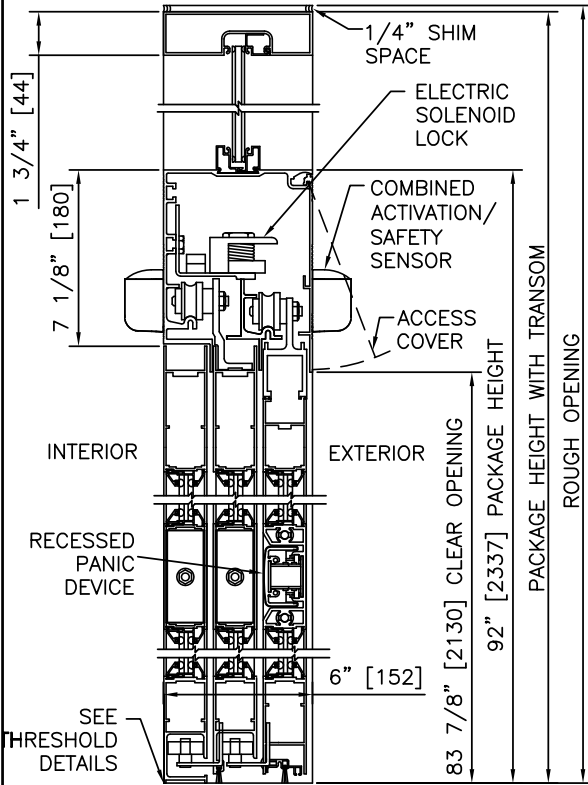

NOTES

1. ELECTRICAL REQUIREMENTS: BY ELECTRICAL CONTRACTOR 120 VAC, 5 AMP MIN TO POWER OPERATOR CONTROL CIRCUIT FROM SECURE ACTIVATION TO OPERATOR
2. ROUGH OPENING SHALL PROVIDE 1/4"[6] SHIM SPACE ON SIDES AND TOP OF PACKAGE.
3. LIMITS OF ACTIVATION AND SAFETY ZONES ARE FOR REFERENCE ONLY; SEE ANSI/BHMA A156.10 FOR DETAILED REQUIREMENTS.
4. SEE SPECIFICATIONS FOR ADDITIONAL INFORMATION.

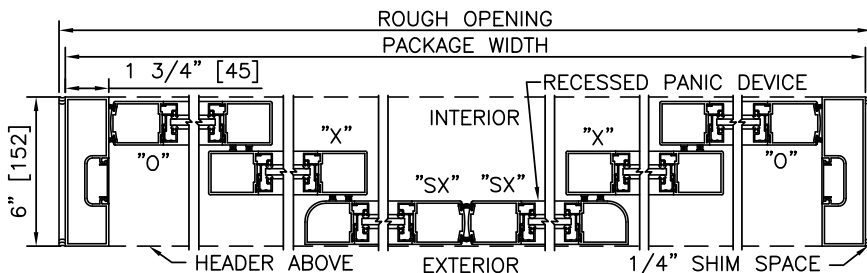

TYPICAL PACKAGE DIMENSIONS (NARROW STILE)

PACKAGE WIDTH	NOMINAL CLEAR DOOR OPENING	SLIDING DOOR PANEL NOMINAL WIDTH	EMERGENCY BREAKOUT NOM. WIDTH
120"	59.5"	21.0"	37.1"
144"	75.5"	25.0"	45.1"
168"	91.5"	29.0"	53.1"

**DURA-GLIDE
5200
SERIES**

6-PANEL TELESCOPIC, SURFACE APPLIED

PROJECT INFORMATION

PROJECT NAME:

LOCATION:

DOOR NUMBER(S):

DATE:

SHEET: OF

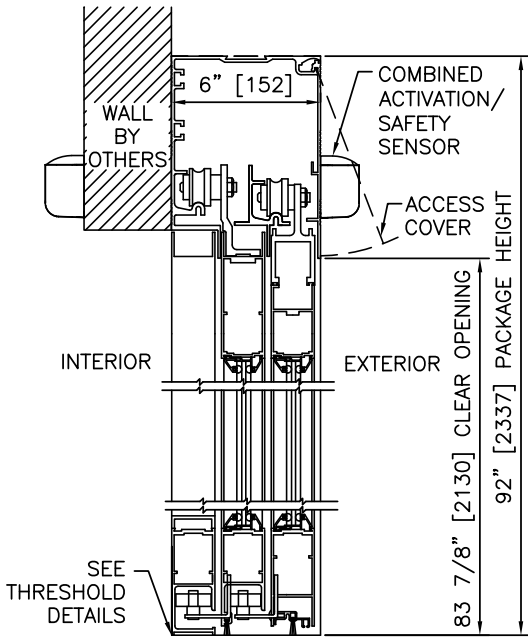

① VERTICAL SECTION

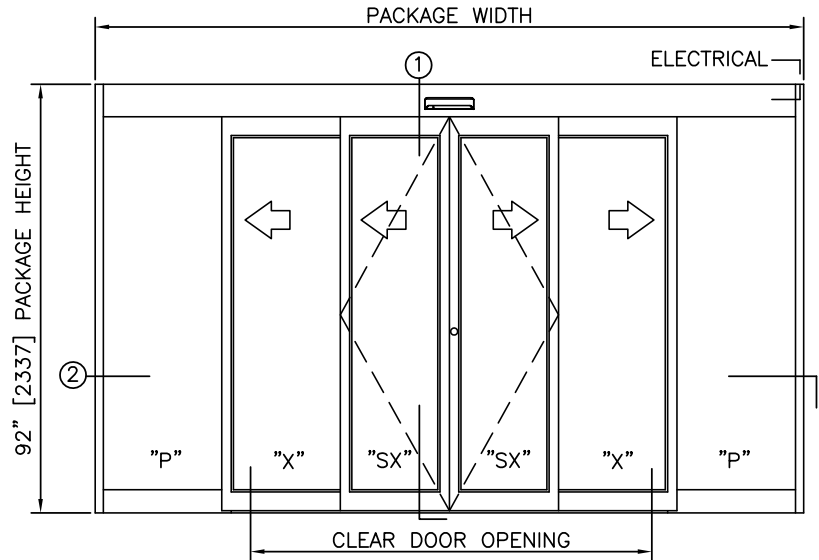

ELEVATION

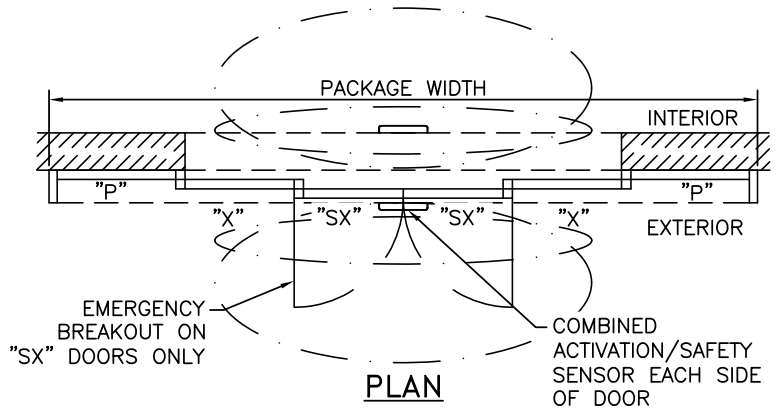

PLAN

NOTES

1. ELECTRICAL REQUIREMENTS: 120 VAC, 5 AMP MIN TO POWER OPERATOR BY ELECTRICAL CONTRACTOR.
2. LIMITS OF ACTIVATION AND SAFETY ZONES ARE FOR REFERENCE ONLY; SEE ANSI/BHMA A156.10 FOR DETAILED REQUIREMENTS.
3. SEE SPECIFICATIONS FOR ADDITIONAL INFORMATION.

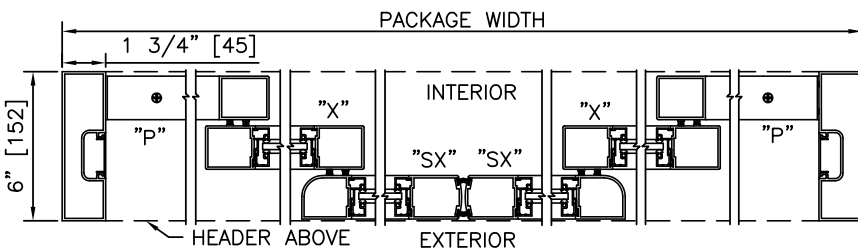

② HORIZONTAL SECTION

TYPICAL PACKAGE DIMENSIONS (NARROW STILE)

PACKAGE WIDTH	NOMINAL CLEAR DOOR OPENING	SLIDING DOOR PANEL NOMINAL WIDTH	EMERGENCY BREAKOUT NOM. WIDTH
120"	59.5"	21.0"	37.1"
144"	75.5"	25.0"	45.1"
168"	91.5"	29.0"	53.1"

**DURA-GLIDE
5200
SERIES**

6-PANEL TELESCOPIC WITH ACCESS CONTROL, RECESSED, SURFACE APPLIED

PROJECT INFORMATION

PROJECT NAME:

LOCATION:

DOOR NUMBER(S):

DATE:

SHEET: OF

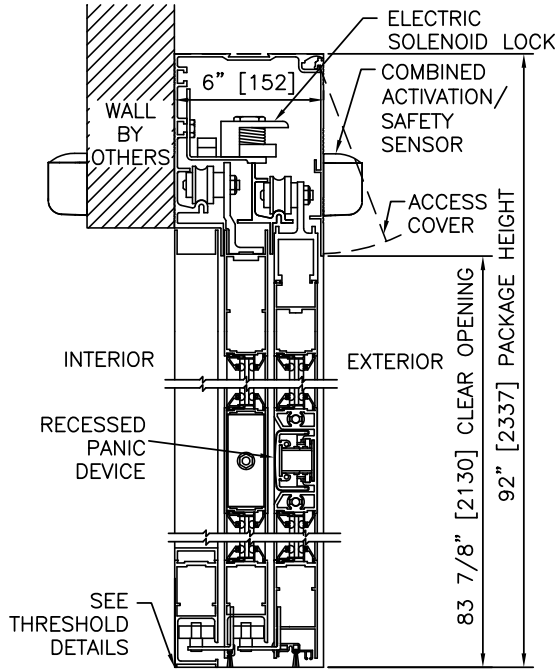

① VERTICAL SECTION

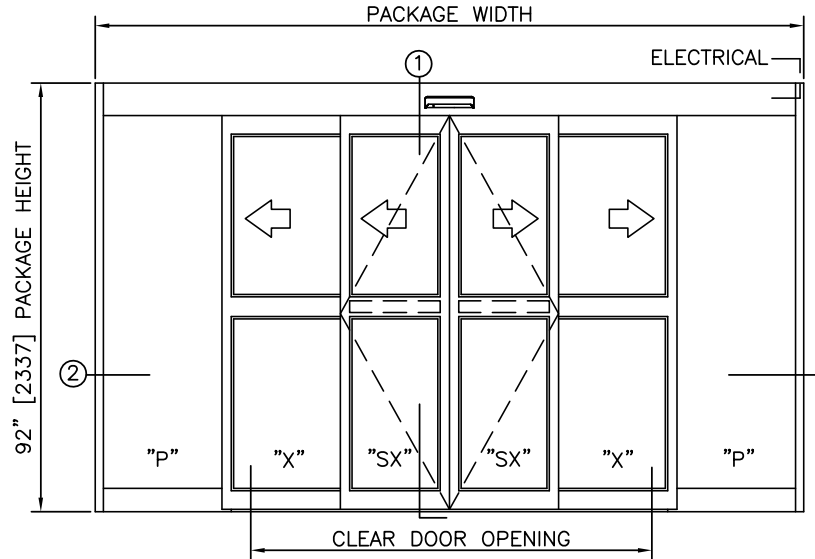

ELEVATION

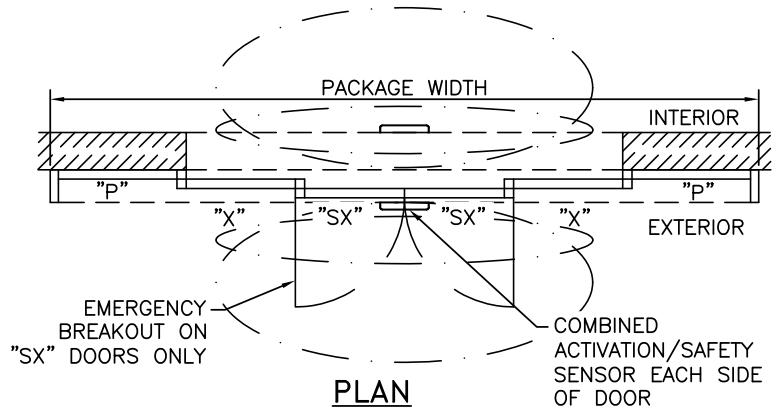

PLAN

NOTES

1. ELECTRICAL REQUIREMENTS: BY ELECTRICAL CONTRACTOR
120 VAC, 5 AMP MIN TO POWER OPERATOR
CONTROL CIRCUIT FROM SECURE ACTIVATION TO OPERATOR
2. LIMITS OF ACTIVATION AND SAFETY ZONES ARE FOR
REFERENCE ONLY; SEE ANSI/BHMA A156.10 FOR DETAILED
REQUIREMENTS.
3. SEE SPECIFICATIONS FOR ADDITIONAL INFORMATION.

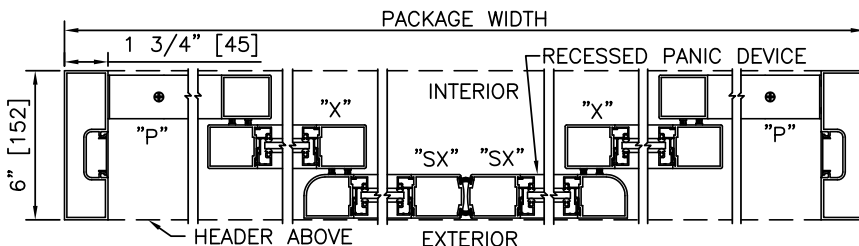

② HORIZONTAL SECTION

TYPICAL PACKAGE DIMENSIONS (NARROW STILE)

PACKAGE WIDTH	NOMINAL CLEAR DOOR OPENING	SLIDING DOOR PANEL NOMINAL WIDTH	EMERGENCY BREAKOUT NOM. WIDTH
120"	59.5"	21.0"	37.1"
144"	75.5"	25.0"	45.1"
168"	91.5"	29.0"	53.1"